

**BALT**<sup>®</sup>

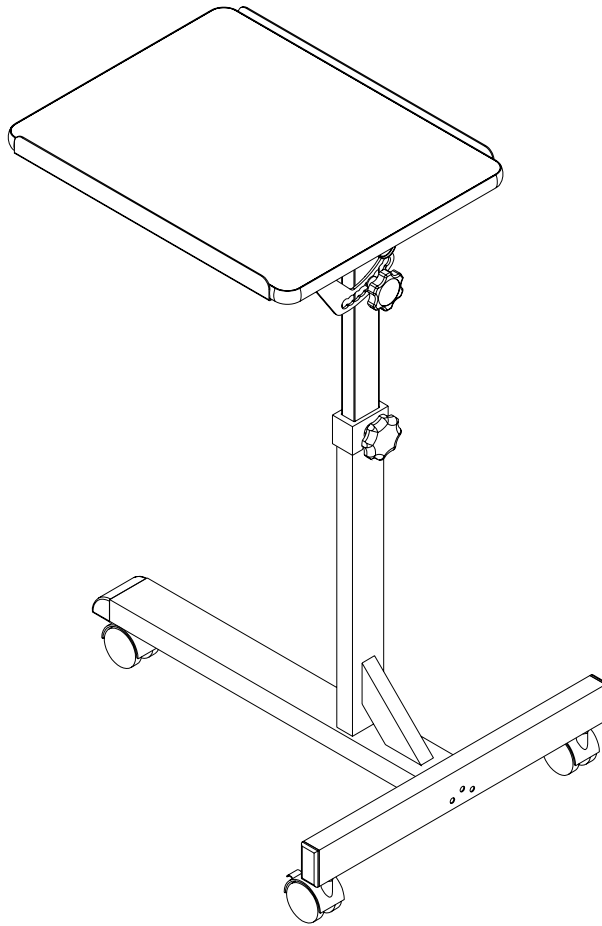









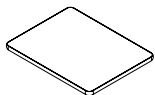

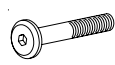

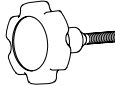







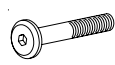

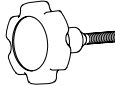





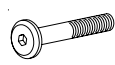

**#89819 Lap-JR**  
Laptop/Reading Desk

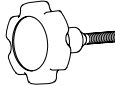

**Assembly Instructions**

# LAP-JR

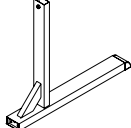
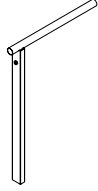
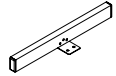
# Laptop/Reading Desk

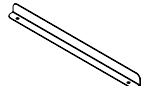
Part	Drawing	Description	Qty	Part	Drawing	Description	Qty																																								
P-1		Top Platform	1 EA	<div style="text-align: center; font-weight: bold; margin-bottom: 10px;">Hardware List</div> <table border="0"> <tr> <td>A</td> <td></td> <td>Socket Screw M6X15mm</td> <td>9 EA</td> </tr> <tr> <td>A1</td> <td></td> <td>Socket Screw M6X45mm</td> <td>3 EA</td> </tr> <tr> <td>B</td> <td></td> <td>Wood Screw 1/2"</td> <td>4 EA</td> </tr> <tr> <td>C</td> <td></td> <td>Large Knob</td> <td>1 EA</td> </tr> <tr> <td>D</td> <td></td> <td>Small Knob</td> <td>1 EA</td> </tr> <tr> <td>E</td> <td></td> <td>2" Locking Caster</td> <td>3 EA</td> </tr> <tr> <td>F</td> <td></td> <td>Allen Wrench</td> <td>1 EA</td> </tr> <tr> <td>G</td> <td></td> <td>Caster Wrench</td> <td>1 EA</td> </tr> <tr> <td>M</td> <td></td> <td>Plastic Cap</td> <td>1 EA</td> </tr> <tr> <td>N</td> <td></td> <td>Plastic Sleeve</td> <td>1 EA</td> </tr> </table>				A		Socket Screw M6X15mm	9 EA	A1		Socket Screw M6X45mm	3 EA	B		Wood Screw 1/2"	4 EA	C		Large Knob	1 EA	D		Small Knob	1 EA	E		2" Locking Caster	3 EA	F		Allen Wrench	1 EA	G		Caster Wrench	1 EA	M		Plastic Cap	1 EA	N		Plastic Sleeve	1 EA
A		Socket Screw M6X15mm	9 EA																																												
A1		Socket Screw M6X45mm	3 EA																																												
B		Wood Screw 1/2"	4 EA																																												
C		Large Knob	1 EA																																												
D		Small Knob	1 EA																																												
E		2" Locking Caster	3 EA																																												
F		Allen Wrench	1 EA																																												
G		Caster Wrench	1 EA																																												
M		Plastic Cap	1 EA																																												
N		Plastic Sleeve	1 EA																																												
P-2		Lower Receiver	1 EA																																												
P-3		Upper Insert	1 EA																																												
P-4		Foot	1 EA																																												
P-5		C-Clamp	2 EA																																												
P-6		Tilting Bracket	1 EA																																												
P-7		Security Stop	2 EA																																												

Tools required: Phillips Head Screw Driver

Do not use unless all screws are tight. At least every six months, check all screws to be sure they are tight. If parts are missing, broken, damaged, or worn, stop use of the product until repairs are made by your dealer using factory authorized parts.

# LAP-JR Assembly Diagram



**READ THROUGH INSTRUCTIONS FROM BEGINNING TO END BEFORE STARTING TO ASSEMBLE UNIT.**

- 1.) Identify and Separate all the Parts and Hardware.
- 2.) Attach Foot (P-4) on the end of Lower Receiver (P-2) using 3 Flat Head screws (A1).  
(Do not tighten screws all the way.)
- 3.) Secure Foot (P-4) on the end of Lower Receiver (P-2) using 2 Flat Head screws (A).
- 4.) Insert 3 Locking Casters (E) into Lower Receiver (P-1) and Foot (P-4) as shown in illustration # 1. Tighten all Casters using Caster Wrench (G).

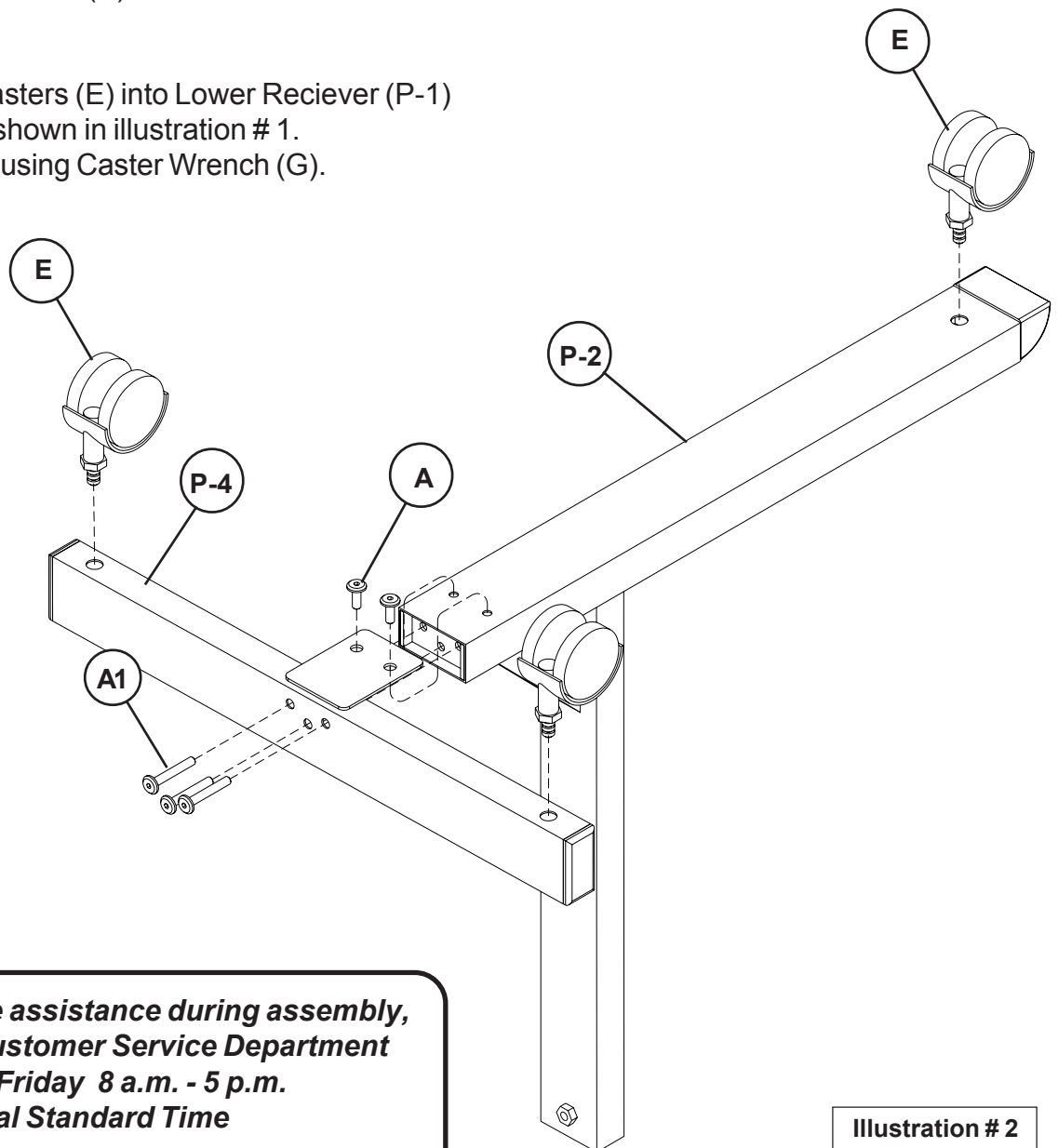

**Should you require assistance during assembly,  
please call our Customer Service Department  
Monday - Friday 8 a.m. - 5 p.m.  
Central Standard Time**

**Toll-Free Customer Service  
1-800-749-2258**

Illustration # 2

5.) Attach Top Platform (P-1) to Upper Insert (P-3) using 2 C-Clamps (P-5) and 4 Flat Head screws (A) as shown in illustration # 2.

6.) Attach 2 Security Stops (P-7) using 4 Wood screws (B) and philips head screwdriver.

7.) Attach Tilting Bracket (P-6) to the Top Platform (P-1) using 2 Flat Head screws (A). Secure Tilting Bracket to Upper Insert (P-3) using the Large Knob (C).

8.) Tighten all the screws at this time using Allen Wrench (F).

Illustration # 2

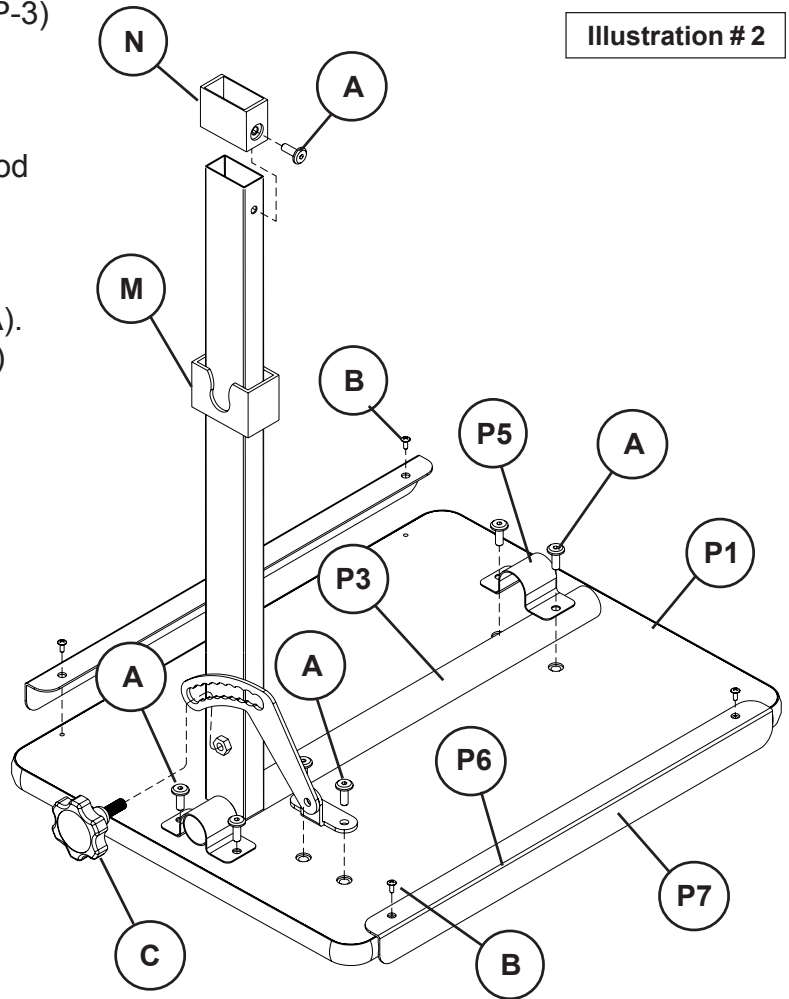
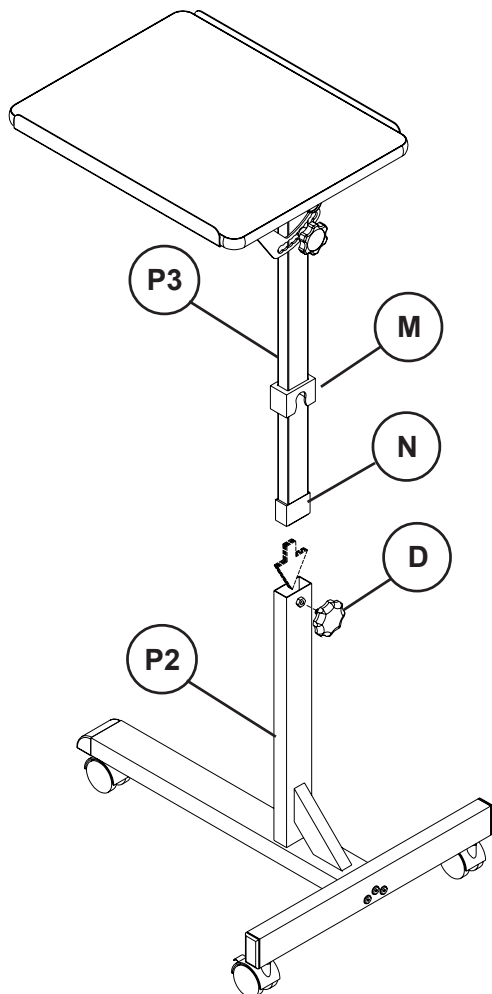

Illustration # 3



9.) Slide Plastic Cap (M) on the Upper insert (P-3) with Cutout on the same side as the tilting bracket as shown in illustration # 2. Attach the Plastic sleeve (N) over the end of insert. Make sure that the hole on the Part N and the hole on the Upper insert (P-3) line up, then secure it with a Flat Head screw (A).

10.) Insert Upper insert (P-3) into the Lower Receiver (P-2) as shown in illustration # 3. Slide Part M down, so that it is resting on top of the Lower Receiver Tube (P-2). Adjust to the desired height and secure with the Small Knob (D) as shown in Illustration #3.

# #89819 Lap-Jr Laptop/Reading Desk



For more information  
1-800-749-2258

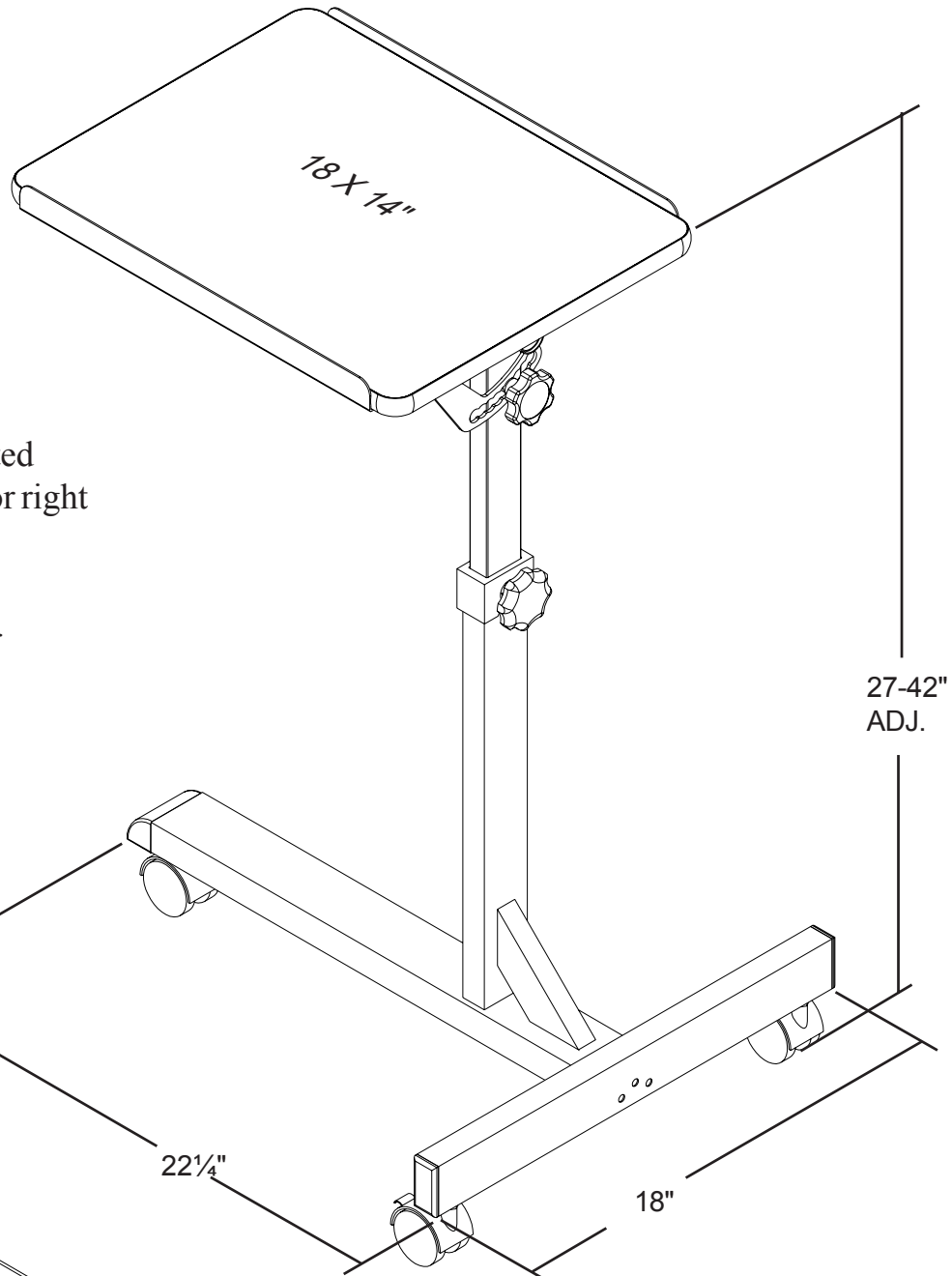
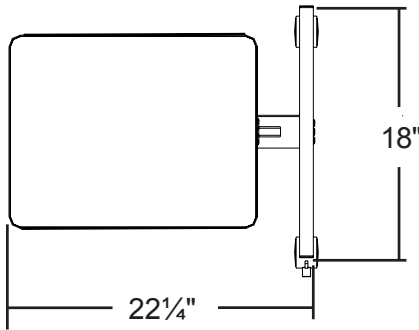

Work surface can be rotated positive or negative 45° for right or left handed use.

Includes 3 locking casters.

Ships UPS.

Shipping Information  
1.4 Cubic Feet  
20 lbs.

